





## SK2- Nastratrice semiautomatica - Semi-automatic carton sealer - Machine d'emballage semi-automatique - Halbautomatische verschliessmaschine - Precintadora semiautomática

 **SK2**- Nastratrice semiautomatica a dimensionamento manuale con guide laterali autocentranti. Facile da usare e semplice nelle regolazioni, consente ad ogni operatore di avviarla alla produzione in pochi minuti. Con il doppio sistema di trascinamento superiore/inferiore e la collaudatissima unità nastrante K11, assicura una perfetta chiusura della scatola con nastro adesivo. La macchina è stata progettata e costruita con riferimento alla **Direttiva Macchine CE 392 e Successivi Aggiornamenti**.

 **SK2** - Semi-automatic carton sealer with manual adjustment and self-centering lateral guides. Easy to be used and simple to be adjusted, it can be started by any operator in few minutes. It allows a perfect closing of the box by adhesive tape thanks to the double top and bottom driving system and the super reliable taping unit K11. The carton sealer has been designed and built according to the **CE 392 Machine Directives and subsequent revisions**.

 **SK2** - Machine semi-automatique à réglage manuel avec guides latéraux autoréglables. Facile à employer et simple dans les réglages, elle donne la possibilité à tout opérateur de la faire marcher dans quelques minutes. Avec le double système d'entraînement supérieur/inferieur et la très essayée unité d'enrubannage K11, elle est en mesure d'assurer une fermeture parfaite de la boîte parmi le ruban adhésif. La machine a été projetée et construite selon la **Directive Européenne sur les machines CE 392 ainsi que ses mises à jour successives**.

 **SK2** - Halbautomatische Verschliessmaschine mit manueller Bemassung mit seitlichen selbstzentrierenden Führungen. Einfache Verbrauch und einfach zu verstellen, erlaubt die Maschine jedem Bediener sie ganz schnell zum Arbeit zu vorbereiten. Durch das doppelte obige und untere Förderungssystem und durch die hochgetesteten Verschliesseinheiten K11, versichert die Maschine einen einwandfreien Verschluss der Schachtel mittels Klebeband. **Die Maschine ist mit Bezeichnung an den EEC Richtlinien 392 und nach den neuesten Ergänzungen entworfen und gebaut worden.**

 **SK2** - Precintadora semiautomática a dimensionamiento manual con guías laterales autocentrantes. Fácil de usar y de sencilla regulación, permite que el operador, la ponga en funcionamiento en pocos minutos. Con el doble sistema de arrastre superior/inferior y la más que probada unidad precintadora K11, asegura un cierre perfecto de la caja con cinta adhesiva. La máquina ha sido proyectada y construida con referencia a la **Directiva Máquinas CE 392 y versione sucesivas**.

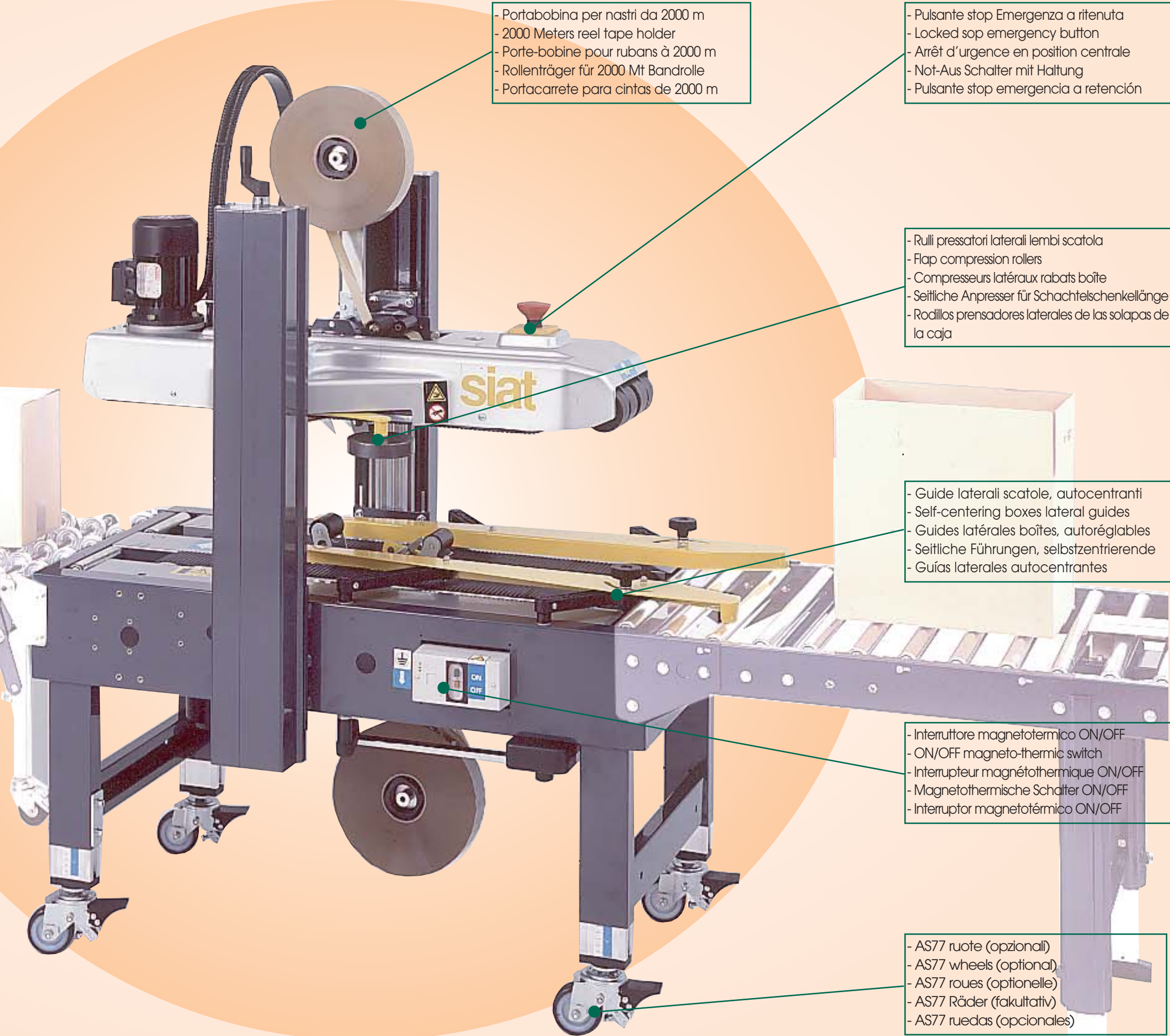

- Portabobina per nastri da 2000 m
- 2000 Meters reel tape holder
- Porte-bobine pour rubans à 2000 m
- Rollenträger für 2000 Mt Bandrolle
- Portacarrete para cintas de 2000 m

- Pulsante stop Emergenza a ritenuta
- Locked stop emergency button
- Arrêt d'urgence en position centrale
- Not-Aus Schalter mit Haltung
- Pulsante stop emergencia a retención

- Rulli pressatori laterali lembi scatola
- Flap compression rollers
- Compresseurs latéraux rabats boîte
- Seitliche Anpresser für Schachtelschenkellänge
- Rodillos prensadores laterales de las solapas de la caja

- Guide laterali scatole, autocentranti
- Self-centering boxes lateral guides
- Guides latérales boîtes, autoréglables
- Seitliche Führungen, selbstzentrierende
- Guías laterales autocentrantes

- Interruttore magnetotermico ON/OFF
- ON/OFF magneto-thermic switch
- Interrupteur magnétothermique ON/OFF
- Magneto-thermische Schalter ON/OFF
- Interruptor magnetotérmico ON/OFF

- AS77 ruote (opzionali)
- AS77 wheels (optional)
- AS77 roues (optionelle)
- AS77 Räder (fakultativ)
- AS77 ruedas (opcionales)



# SK2

- ◆ Caratteristiche tecniche
- ◆ Technical specifications
- ◆ Caractéristiques
- ◆ Eigenschaften
- ◆ Características técnicas

- ◆ Accessori
- ◆ Optionals
- ◆ Accessoires
- ◆ Zubehör
- ◆ Accesorios

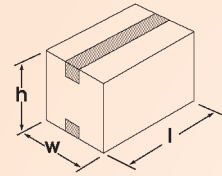

	MIN	MAX
l	150	
w	140	500
h	110	500

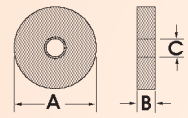

A	= 410 mm max.
B	= 50 mm
C	= 76 mm

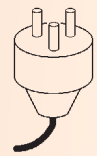

380÷440 • Trifase • 3 Phase • Tri-phasé  
• 3-phasig • Trifásico

220÷240 • Monofase • Single phase  
• Mono-phasé • 1 phasig  
• Monofásico

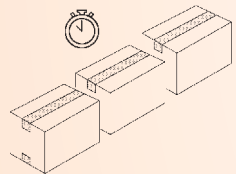

Produzione media: 800 scatole/ora  
Output: 800 boxes per hour  
Production moyenne: 800 boîtes/heure  
Leistung: 800 Schachtel/Stunde  
Producción media: 800 cajas/hora

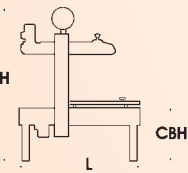

H	= 1238÷1955 mm
CBH	= 480÷820 mm
L	= 1240 mm
W	= 740 mm

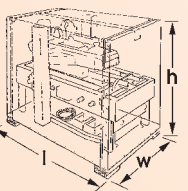

h	= 1100 mm
w	= 80 mm
l	= 130 mm



#### AS77

- ◆ Set ruote Ø100 mm
- ◆ Casters
- ◆ Roues
- ◆ Satz Umlaufräder
- ◆ Set ruedas



#### AS80

- ◆ Set gambe più alte (600 mm)
- ◆ Higher legs (600 mm/24")
- ◆ Pieds plus hauts (600 mm)
- ◆ Höhere Stützen (600 mm)
- ◆ Set patas mas altas (600 mm)

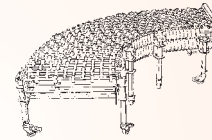

#### GTM-GTL-GTR

- ◆ Piani estensibili
- ◆ Extendable conveyors
- ◆ Convoyeurs extensibles
- ◆ Ausziehbare Rollenbahnen
- ◆ Plano de rodillos extensibles

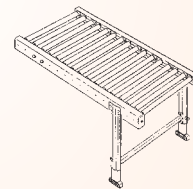

#### RN/RG

- ◆ Piani a rulli
- ◆ Idler roller conveyors
- ◆ Plans à rouleaux
- ◆ Rollenbahnen
- ◆ Tramo de rodillos

MARCATORE A GETTO D'INCHIOSTRO - INK-JET MARKER - MARQUEURS A JET D'ENCRE - TINTENSTRAHLMARKIERER - MARCADOR INK-JET

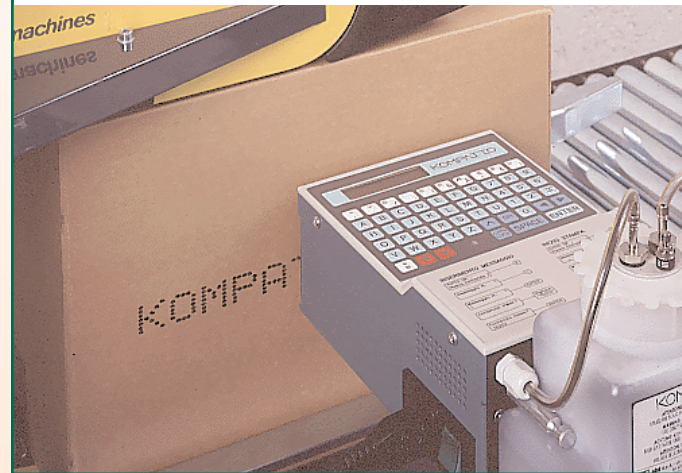

Cod. pubbl.: 5.6.00225.01

# SIAT

M. J. MAILLIS GROUP

the new generation

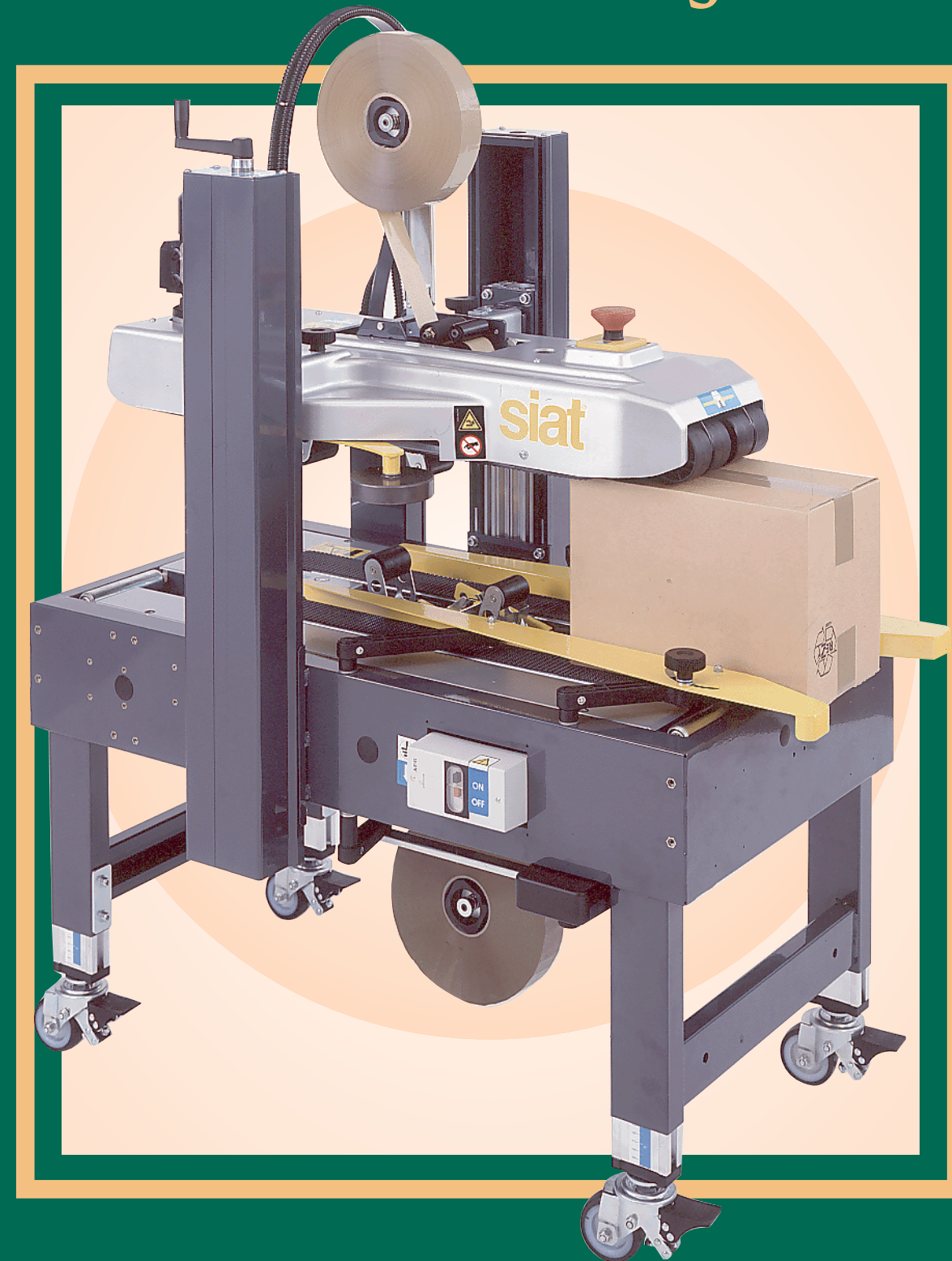

**SK2** Nastratrice semiautomatica  
Semi-automatic carton sealer  
Machine d'emballage semi-automatique  
Halbautomatische Verschlussmaschine  
Precintadora semiautomática

